

JHK100N120FA

Product Preview

1200V/100A FIELD-STOP TRENCH IGBT WITH DIODE

Features

- Low $V_{CE(sat)}$
- Fast Switching
- High Ruggedness
- Short-Circuit Rated

Product Summary

V_{CES}	1200V
I_C	100A ⁽¹⁾
$V_{CE(sat),typ}$	1.65V ($T_J = 25^\circ\text{C}$)
Package	TO-264

Applications

- Inverters
- Frequency Converters
- Industrial Motor Drives
- Uninterrupted Power Supply

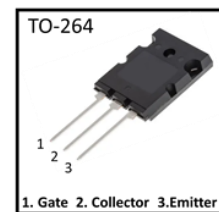
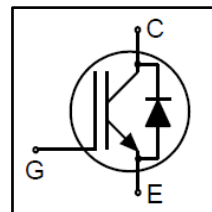
Ordering Information

Part Number	Marking	Package	Packing
JHK100N120FA	HK100N120FA	TO-264	Tube

Absolute Maximum Ratings

Parameter	Symbol	Limit	Unit
Collector-to-Emitter Voltage	V_{CES}	1200	V
Gate-to-Emitter Voltage	V_{GES}	± 20	
DC Collector Current ($T_c = 25^\circ\text{C}$, $T_J = 150^\circ\text{C}$)	I_C	160 ⁽²⁾	A
DC Collector Current ($T_c = 100^\circ\text{C}$, $T_J = 150^\circ\text{C}$)		103	
Pulsed Collector Current (pulse width limited by maximum T_J)	I_{CM}	300	
Diode Forward Current ($T_c = 25^\circ\text{C}$, $T_J = 150^\circ\text{C}$)	I_F	160 ⁽²⁾	
Diode Forward Current ($T_c = 100^\circ\text{C}$, $T_J = 150^\circ\text{C}$)		100	
Diode Pulsed Current (pulse width limited by maximum T_J)	I_{FM}	300	
Short Circuit Withstand Time ($V_{GE} = 15\text{V}$, $V_{CC} \leq 600\text{V}$, $T_{J_start} \leq 150^\circ\text{C}$)	t_{SC}	10	μs
Turn-off Safe Operating Area ($V_{CE} \leq 1200\text{V}$, $T_J \leq 150^\circ\text{C}$)	-	300	A
Maximum Power Dissipation ($T_c = 25^\circ\text{C}$, $T_J = 150^\circ\text{C}$)	$P_{D(max)}$	696	W
Operating Junction Temperature	T_J	-40 to +150	$^\circ\text{C}$
Storage Temperature	T_{stg}	-55 to +150	
Maximum Lead Temperature for Soldering (1/8" from case for 5 seconds)	T_{slid}	260	

Static Electrical Characteristics ⁽³⁾

Parameter	Symbol	Test Conditions	Min	Typ	Max	Unit
Collector-to-Emitter Breakdown Voltage	BV_{CES}	$V_{GE} = 0V, I_C = 250\mu A$	1200	-	-	V
Collector-to-Emitter Leakage Current	I_{CES}	$V_{CE} = 1200V, V_{GE} = 0V$	-	-	10	μA
		$V_{CE} = 1200V, V_{GE} = 0V,$ $T_J = 150^\circ C$	-	-	5	mA
Gate-to-Emitter Leakage Current	I_{GES}	$V_{CE} = 0V, V_{GE} = \pm 20V$	-	-	100	nA
Gate Threshold Voltage	$V_{GE(th)}$	$V_{CE} = V_{GE}, I_C = 1.5mA$	5.5	6.5	7.5	V
Collector-to-Emitter Saturation Voltage	$V_{CE(sat)}$	$V_{GE} = 15V, I_C = 100A$	-	1.65	2.0	
		$V_{GE} = 15V, I_C = 100A,$ $T_J = 150^\circ C$	-	2.2	-	
Diode Forward Voltage	V_F	$V_{GE} = 0V, I_F = 100A$	-	1.85	2.25	
		$V_{GE} = 0V, I_F = 100A$ $T_J = 150^\circ C$	-	1.6	-	

Thermal Characteristics

Parameter	Symbol	Min	Typ	Max	Unit
Junction-to-Ambient Thermal Resistance	$R_{\theta JA}$	-	-	25	$^\circ C/W$
Junction-to-Case Thermal Resistance, IGBT	$R_{\theta JC}$	-	-	0.18	
Junction-to-Case Thermal Resistance, Diode		-	-	0.26	

Dynamic Electrical Characteristics ⁽³⁾

Parameter	Symbol	Test Conditions	Min	Typ	Max	Unit
Total Gate Charge	Q_g	$V_{CC} = 600V,$ $V_{GE} = 15V,$ $I_C = 100A$	-	478	-	nC
Input Capacitance	C_{iss}	$V_{CE} = 25V,$ $V_{GE} = 0V,$ $f = 1MHz$	-	9605	-	pF
Output Capacitance	C_{oss}		-	413	-	
Reverse Transfer Capacitance	C_{rss}		-	98	-	

Switching Characteristics, Inductive Load ^{(3), (4)}

Parameter	Symbol	Test Conditions	Min	Typ	Max	Unit
Turn-on Delay time	$t_{d(ON)}$	$V_{CC} = 600V,$ $V_{GE} = 0/15V,$ $R_G = 1\Omega,$ $I_C = 100A,$ $L_{load} = 0.82mH,$ Energy losses include "tail" and diode reverse recovery.	-	62	-	ns
Rise Time	t_r		-	90	-	
Turn-off Delay time	$t_{d(OFF)}$		-	280	-	
Fall Time	t_f		-	119	-	
Turn-On Switching Loss	E_{on}		-	9.37	-	mJ
Turn-Off Switching Loss	E_{off}		-	5.07	-	
IGBT Total Switching Loss	E_{ts}		-	14.44	-	
Diode Reverse-Recovery Time	t_{rr}	$V_R = 600V,$ $I_F = 100A,$ $di_F/dt = 900A/\mu s$	-	249	-	ns
Diode Reverse-Recovery Charge	Q_{rr}		-	5160	-	nC
Diode Peak Reverse-Recovery Current	I_{rrm}		-	37	-	A
Short Circuit Collector Current	$I_{C(SC)}$	$V_{GE} = 15V,$ $V_{CC} \leq 600V,$ $t_{SC} \leq 10\mu s$	-	350	-	A

(1) DC collector current, $T_c = 102^\circ C$, $T_j = 150^\circ C$.

(2) Limited by bonding wire

(3) $T_j = 25^\circ C$ unless otherwise specified

(4) t_r : from 10% of I_C to 90% of I_C ; t_f : from 90% of I_C to 10% of I_C ;

E_{on} : from 10% of V_{GE} to 10% of V_{CE} ; E_{off} : from 90% of V_{GE} to 10% of I_C .

Typical Electrical Characteristics

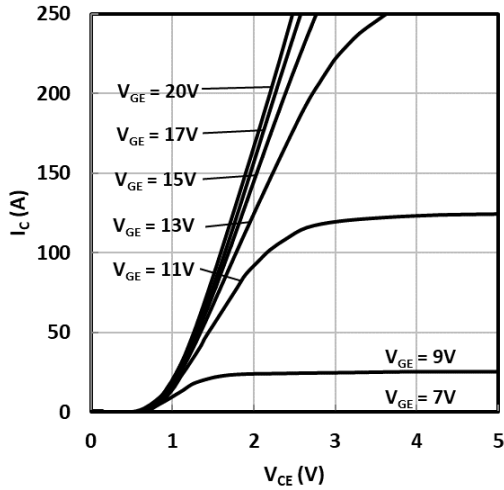

Fig. 1 Typical output characteristics
($T_J = 25^\circ\text{C}$, $t_p = 250 \mu\text{s}$)

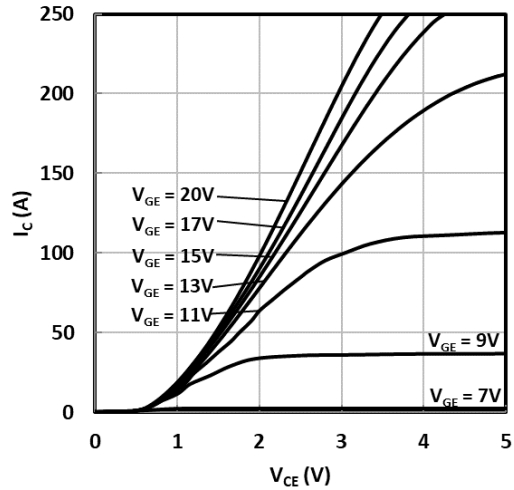

Fig. 2 Typical output characteristics
($T_J = 150^\circ\text{C}$, $t_p = 250 \mu\text{s}$)

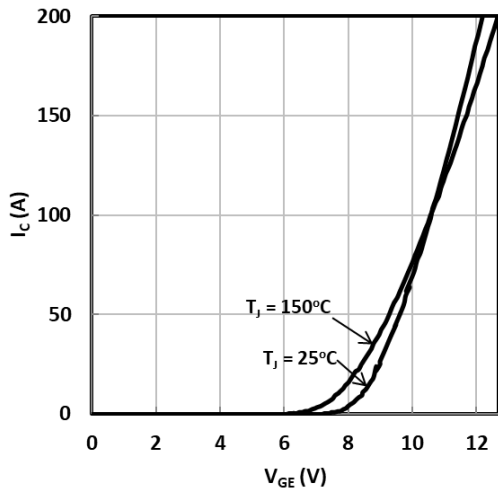

Fig. 3 Typical transfer characteristics
($V_{CE} = 20\text{V}$, $t_p = 250 \mu\text{s}$)

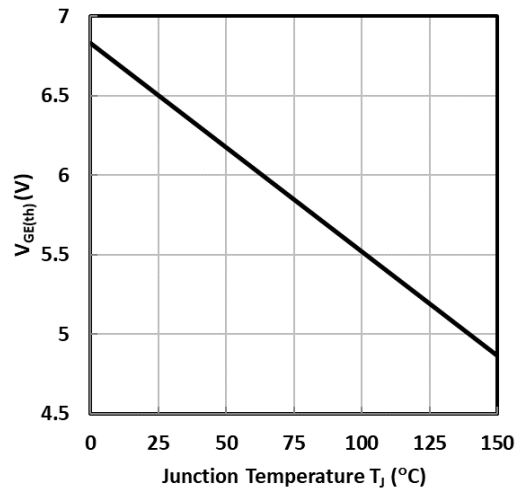

Fig. 4 Typical gate threshold voltage as a function of junction temperature
($V_{CE} = V_{GE}$, $I_C = 1.5\text{mA}$)

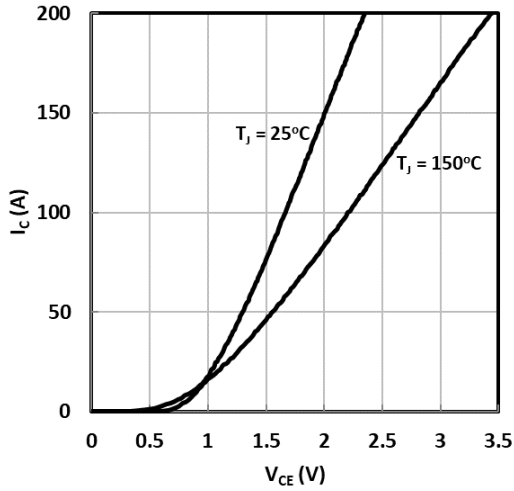

Fig. 5 Typical saturation voltage characteristics
($V_{GE} = 15\text{ V}$, $t_p = 250\ \mu\text{s}$)

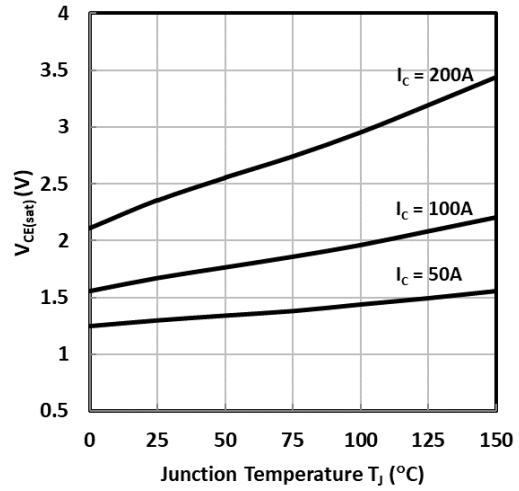

Fig. 6 Typical saturation voltage as a function of junction temperature
($V_{GE} = 15\text{ V}$, $t_p = 250\ \mu\text{s}$)

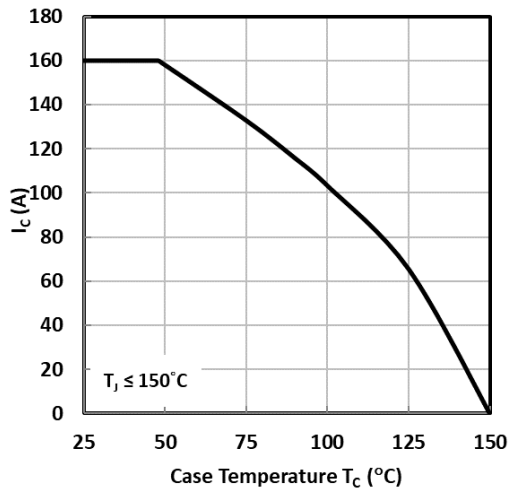

Fig. 7 Maximum DC collector current as a function of case temperature

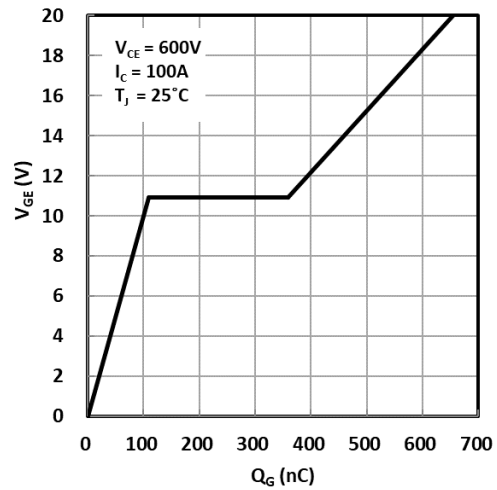

Fig. 8 Typical gate charge characteristics

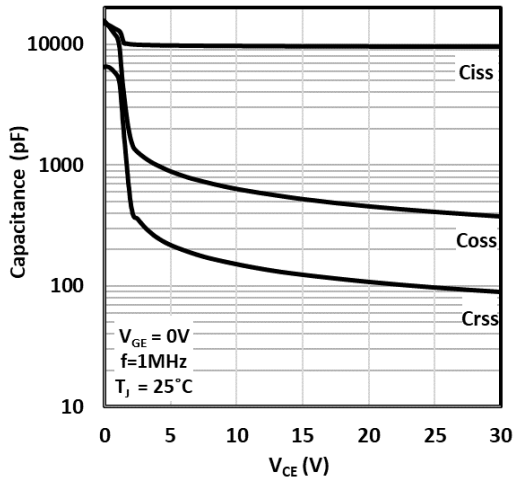

Fig. 9 Typical capacitance as a function of collector-to-emitter voltage

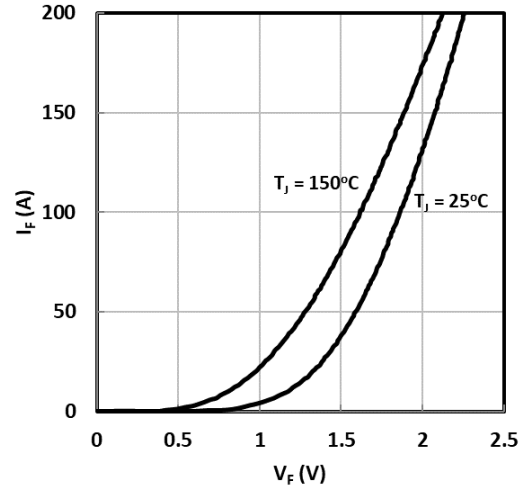

Fig. 10 Typical diode forward current as a function of forward voltage
($V_{GE} = 0V$, $t_p = 250 \mu s$)

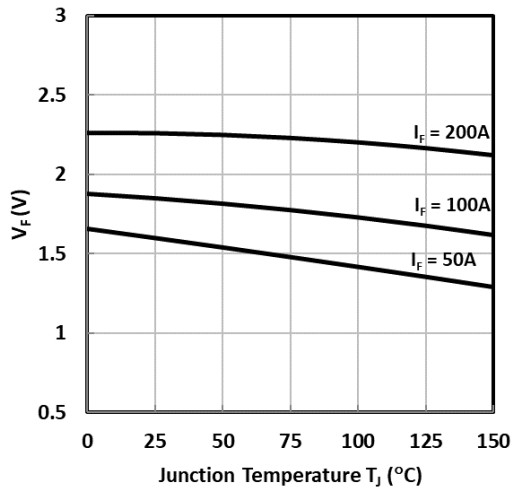
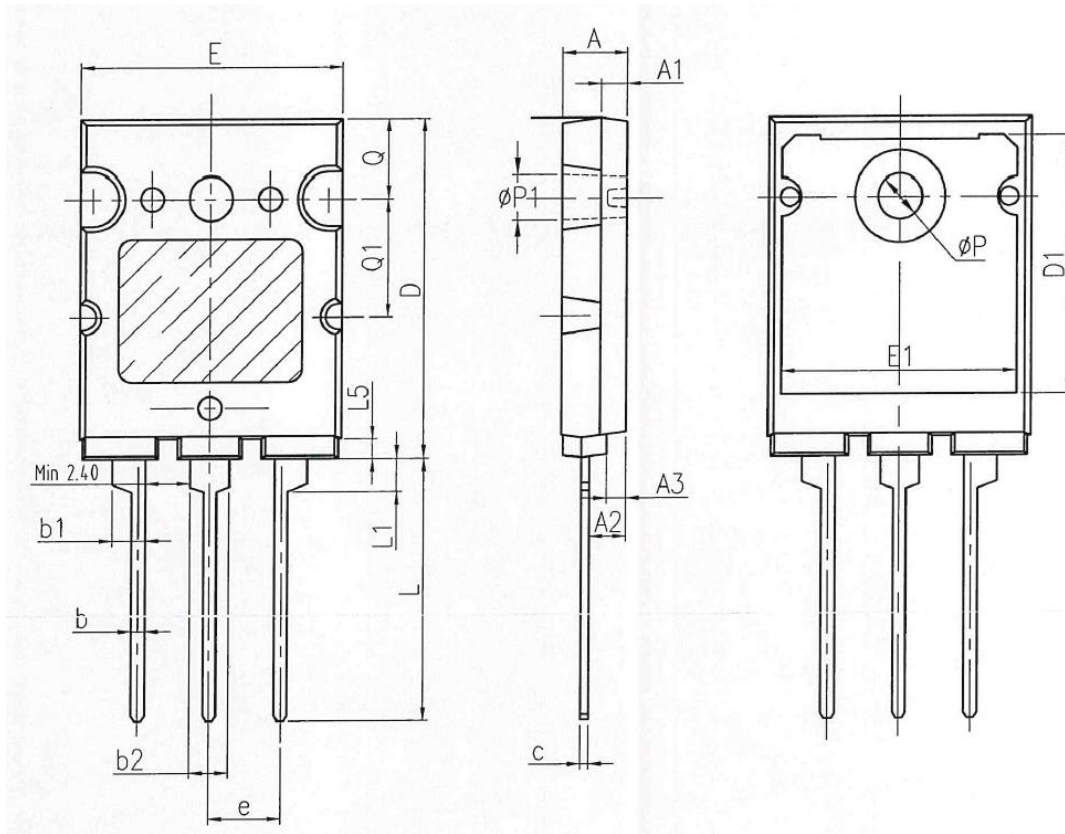

Fig. 11 Typical diode forward voltage as a function of junction temperature

Package Drawing



SYMBOL	mm		
	MIN	NOM	MAX
A	4.80	5.00	5.20
A1	2.00		REF
A2	2.50	2.80	3.10
A3	1.50		REF
b	0.90	1.00	1.25
b1	2.30	2.50	2.75
b2	2.80	3.00	3.20
c	0.50	0.60	0.85
D	25.70	26.00	26.30
D1	19.00	-	-
E	19.50	20.00	20.50
E1	16.00	-	-
e	5.45 TYP		
L	19.50	20.00	20.50
L1	2.20	2.50	2.70
L5	1.35		REF
ΦP	3.00	3.20	3.40
ΦP1	3.20	3.40	3.60
Q	5.80	6.00	6.20
Q1	8.80	9.00	9.20

TO-264

Revision history of JHK100N120FA Specification

Version	Change Items	Effective Date
1.00	Initial Release	10-Aug-21

Notice

General – Information in this document is believed to be accurate and reliable. However, JSAB Technologies does not give any representations or warranties, expressed or implied, as to the accuracy or completeness of such information and shall have no liability for the consequences of use of such information.

Right to make changes – JSAB Technologies reserves the right to make changes to information published in this document, including without limitation specifications and product descriptions, at any time and without notice. This document supersedes and replaces all information supplied prior to the publication hereof.

Suitability for use – JSAB Technologies' products are not designed, authorized or warranted to be suitable for use in medical, military, aircraft, space or life support equipment, nor in applications where failure or malfunction of an JSAB Technologies product can reasonably be expected to result in personal injury, death or severe property or environmental damage. JSAB Technologies accepts no liability for inclusion and/or use of JSAB Technologies' products in such equipment or applications and therefore such inclusion and/or use is at the customer's own risk.

Applications – Applications that are described herein for any of these products are for illustrative purposes only. JSAB Technologies makes no representation or warranty that such applications will be suitable for the specified use without further testing or modification.

Limiting values – Stress above one or more limiting values may cause permanent damage to the device. Limiting values are stress ratings only and operation of the device at these or any other conditions above those given in the Characteristics sections of this document is not implied. Exposure to limiting values for extended periods may affect device reliability.

Terms and conditions of sale – JSAB Technologies' products are sold subject to the general terms and conditions of commercial sale, including those pertaining to warranty, intellectual property rights infringement and limitation of liability, unless explicitly otherwise agreed to in writing by JSAB Technologies. In case of any inconsistency or conflict between information in this document and such terms and conditions, the latter will prevail.

No offer to sell or license – Nothing in this document may be interpreted or construed as an offer to sell products that is open for acceptance or the grant, conveyance or implication of any license under any copyrights, patents or other industrial or intellectual property rights.

Export control – This document as well as the item(s) described herein may be subject to export control regulations. Export might require a prior authorization from national authorities.

Quick reference data – The Quick reference data is an extract of the product data given in the Limiting values and Characteristics sections of this document, and as such is not complete, exhaustive or legally binding.